

Dubbelwoord knipblad. Knip de plaatjes uit en plak de juiste plaatjes naast elkaar

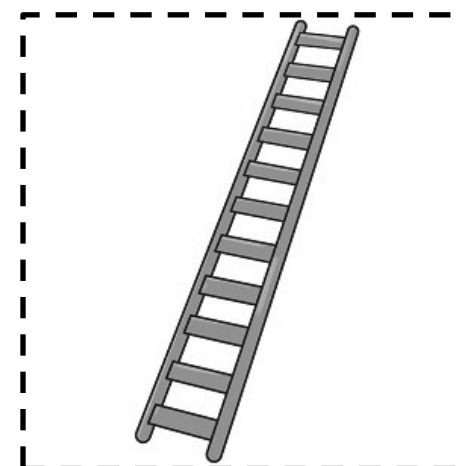

Dubbelwoord kleurblad. Geef de beide stipjes dezelfde kleur als de woorden bij elkaar horen

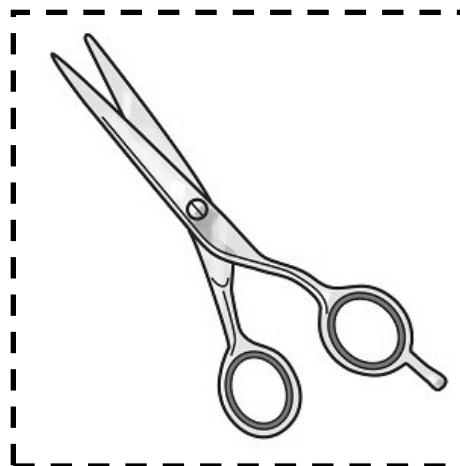
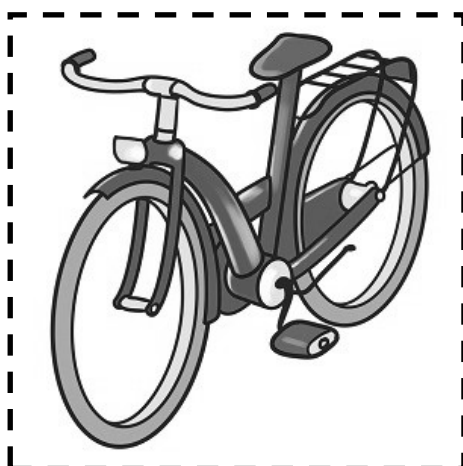
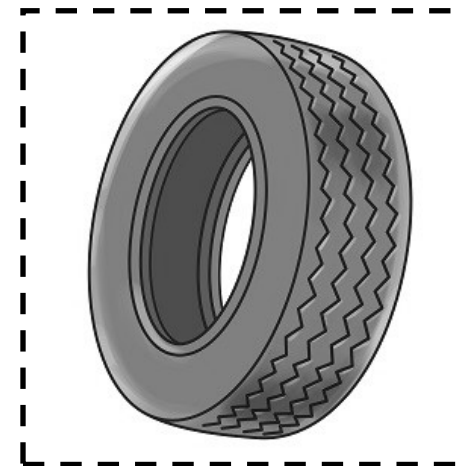
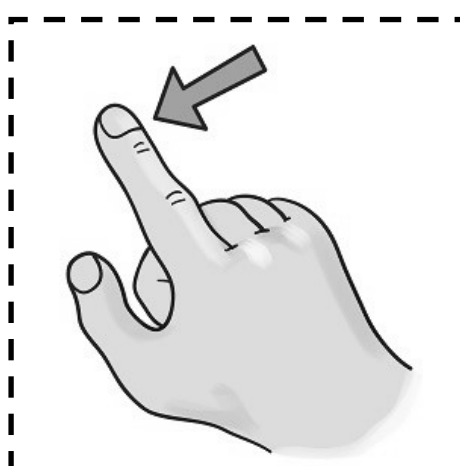
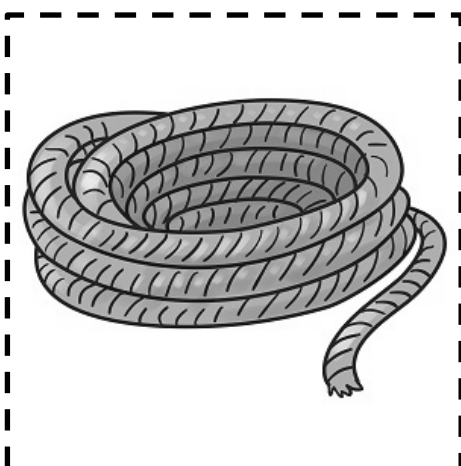
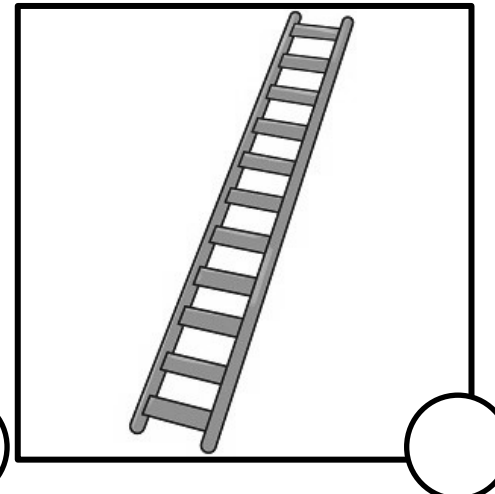
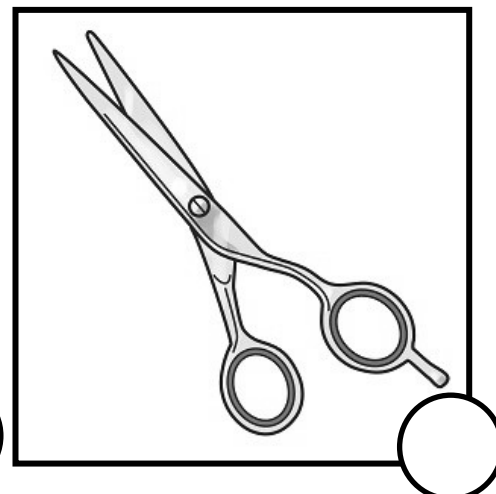
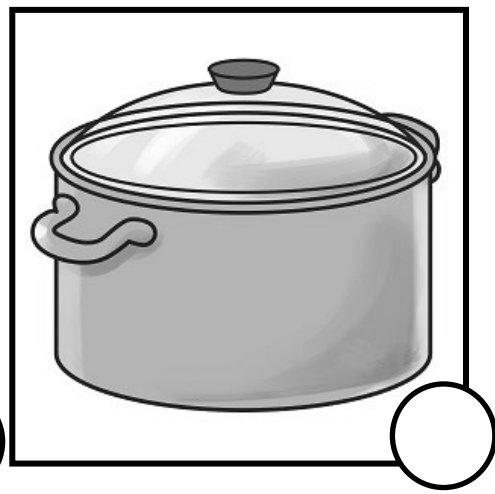
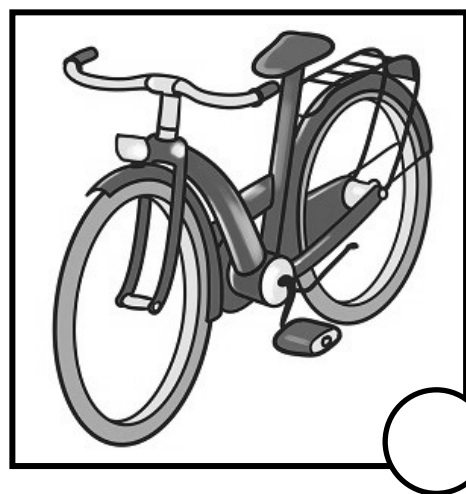
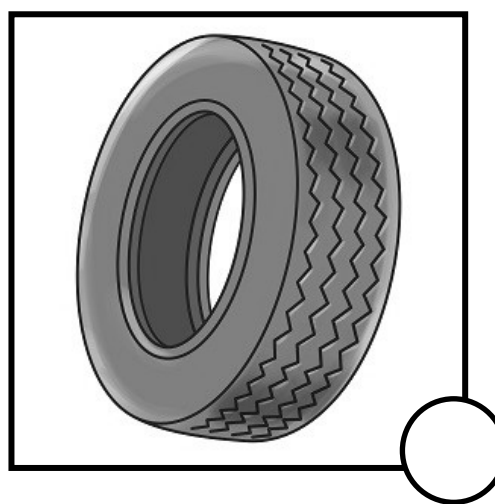
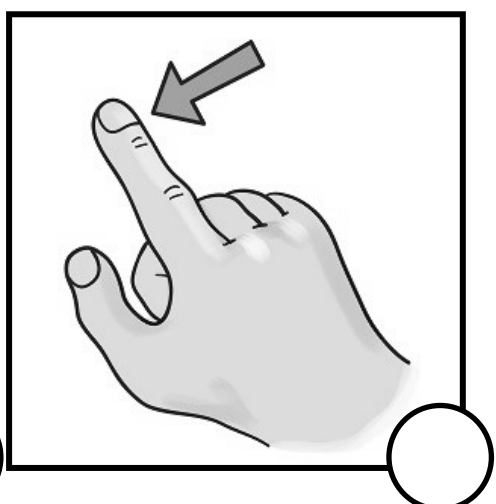
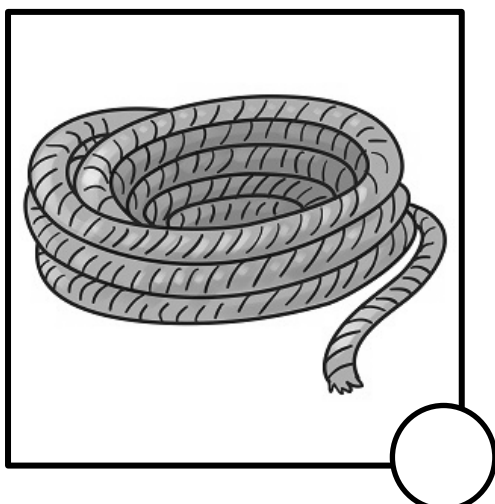
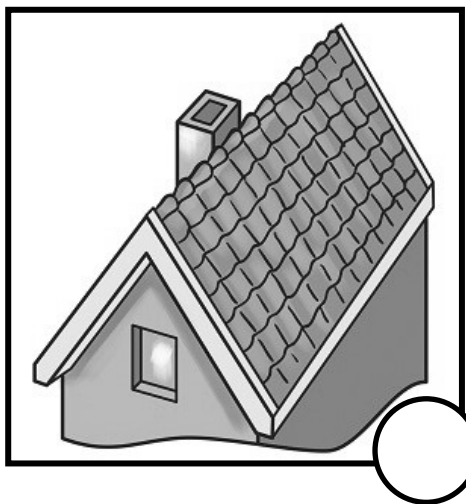

Dubbelwoord praatblad. Noem het woord en leg een gekleurd fiche op het rondje. Kan eht andere kind het andere woord vinden?

Leg daar hetzelfde fiche op

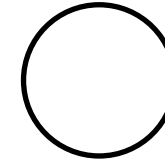
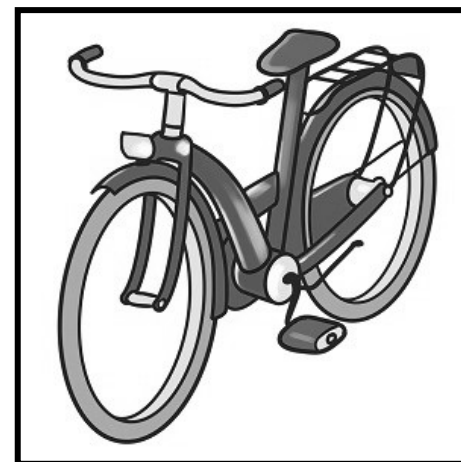
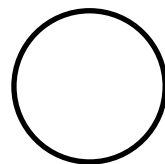
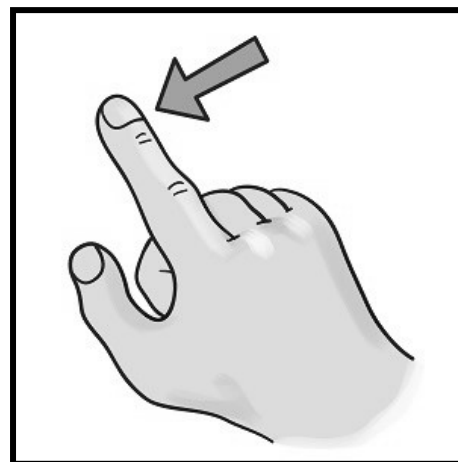
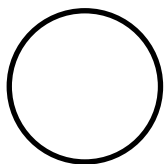
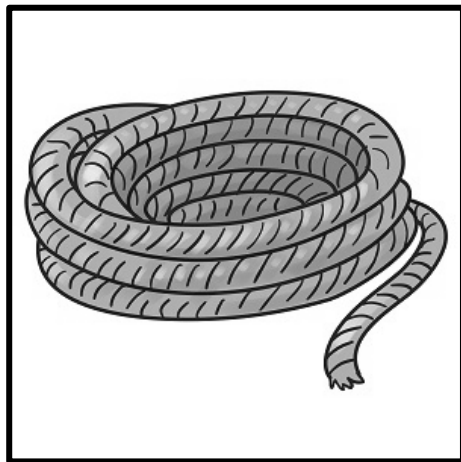
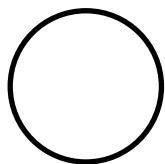

Dubbelwoord praatblad. Noem het woord en leg een gekleurd fiche op het rondje. Kan eht andere kind het andere woord vinden?

Leg daar hetzelfde fiche op

